

▲ WARNING

All repairs, adjustments and maintenance not described in the Operator's Manual must be performed by qualified service personnel.

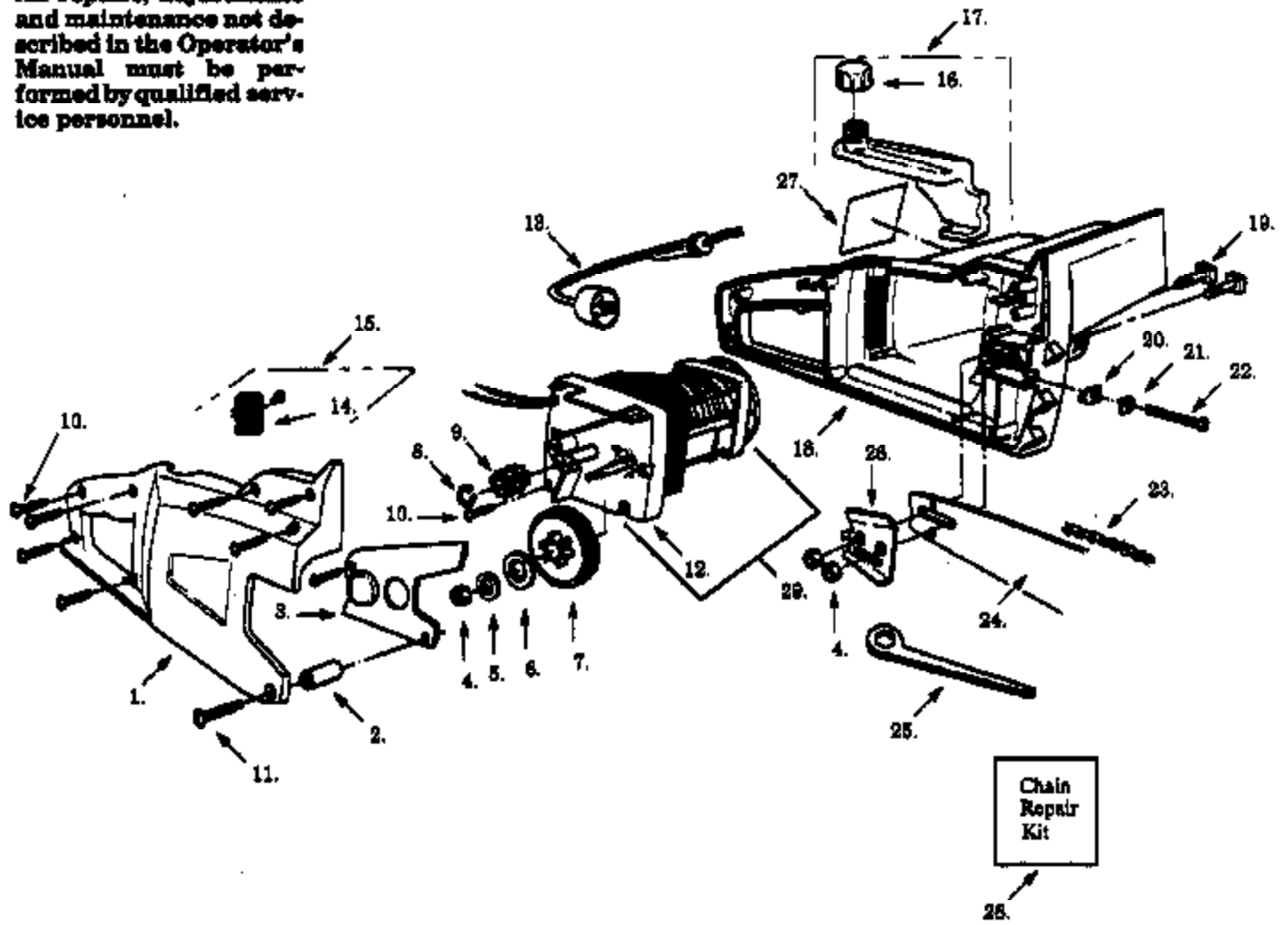

Ref #	Part Number	Qty	Description
1	530029504		Hsg - Right
2	530015832		Spacer
3	530029278		Gear Cover
4	530015251		Nut
5	530015842		Washer
6	530036012		Gear Seal
7	530029341		Gear Assy
8	530015501		Retaining Ring
9	530025463		Pinion Gear
10	530015495		Screw
11	530015835		Screw
12	530029342		Endbell Ass'y.
13	530089765	1425 Electric Saw Page 2 of 8	Model 1220,1420,1425,1625,L-14
13	530401718	CHAIN SAW ASSEMBLY	Model EL-16
14	530025873		Safety Lock Button
15	530025518		Switch (Incl. 14.)
16	530029282		Oil Cap
17	530014254		Oil Tank Assembly
18	530014253		Motor Hsg - Left (Incl. 19)
19	530015831		Bar Mounting Bolt
20	530023492		Pin
21	530025466		Bar Adjusting Plate
22	530015514		Screw
23	952051208		12"
23	952051209		14"
23	952051211		16"
24	952044366		12"
24	952044368		14"
24	952044370		16"
25	530031063		Wrench
26	530029285		Plate
27	530029571		Model 1220
27	530036687		Model 1420
27	530029572		Model 1425
27	530029573		Model 1625
27	530029726		Model EL-14
27	530401694		Model EL-16 (Not a serviceable part)
28	530052073		Chain Repair Kit
29	530014164		Models 1220,1420
29	530014255		Models 1425,1625,EL-14,EL-16
	530082417		Operator's Manual Not Shown.
	530025644		, Scabbard Not Shown.
	530029543		12" & 14" Not Shown.
	530061837		16" Not Shown.
			Carton Not Shown.